



Fisheries and Oceans
Canada

Pêches et Océans
Canada

Ecosystems and
Oceans Science

Sciences des écosystèmes
et des océans

Canadian Science Advisory Secretariat (CSAS)

Research Document 2018/021

Central and Arctic Region

Recovery Potential Modelling of Rainbow Trout, *Oncorhynchus mykiss* (Athabasca River Populations)

Amanda L. Caskenette and Marten A. Koops

Fisheries and Oceans Canada
Great Lakes Laboratory for Fisheries and Aquatic Sciences
867 Lakeshore Rd.
Burlington, ON, Canada
L7S 1A1

Foreword

This series documents the scientific basis for the evaluation of aquatic resources and ecosystems in Canada. As such, it addresses the issues of the day in the time frames required and the documents it contains are not intended as definitive statements on the subjects addressed but rather as progress reports on ongoing investigations.

Research documents are produced in the official language in which they are provided to the Secretariat.

Published by:

Fisheries and Oceans Canada
Canadian Science Advisory Secretariat
200 Kent Street
Ottawa ON K1A 0E6

[http://www.dfo-mpo.gc.ca/csas-sccs/
csas-sccs@dfo-mpo.gc.ca](http://www.dfo-mpo.gc.ca/csas-sccs/csas-sccs@dfo-mpo.gc.ca)



© Her Majesty the Queen in Right of Canada, 2018
ISSN 1919-5044

Correct citation for this publication:

Caskenette, A.L., and Koops M.A. 2018. Recovery Potential Modelling of Rainbow Trout, *Oncorhynchus mykiss* (Athabasca River Populations). DFO Can. Sci. Advis. Sec. Res. Doc. 2018/021. iv + 30 p.

TABLE OF CONTENTS

ABSTRACT.....	IV
RÉSUMÉ	IV
INTRODUCTION	1
METHODS.....	1
SOURCES	1
THE MODEL.....	1
PARAMETER ESTIMATES.....	3
Individual Growth and Mortality	3
Fecundity	6
Population Trajectory	6
POPULATION SENSITIVITY	7
ALLOWABLE HARM.....	8
RECOVERY TARGETS	8
Abundance.....	8
Habitat: Minimum Area for Population Viability (MAPV).....	9
RESULTS	10
POPULATION SENSITIVITY	10
ALLOWABLE HARM.....	12
Allowable Chronic Harm.....	12
Allowable Transient Harm	13
RECOVERY TARGETS	14
Recovery Efforts.....	14
Abundance Targets (MVP).....	15
Habitat Targets (MAPV)	18
DISCUSSION.....	21
SOURCES OF UNCERTAINTY	23
REFERENCES CITED.....	24
APPENDIX 1.....	26
APPENDIX 2.....	27
APPENDIX 3.....	29

ABSTRACT

The Committee on the Status of Endangered Wildlife in Canada (COSEWIC) has assessed the Athabasca River populations of Rainbow Trout (*Oncorhynchus mykiss*) as Endangered in Canada. Here we present population modelling in support of the recovery potential assessment of the species. Results include a sensitivity analysis, determination of allowable harm, and minimum viable population estimates to inform recovery targets for population abundance and required habitat. The analyses demonstrate that the dynamics of Rainbow Trout populations are particularly sensitive to perturbations that affect survival of immature individuals. Harm to these portions of the life cycle should be minimized to avoid jeopardizing the survival and future recovery of Athabasca River Rainbow Trout populations. To achieve demographic sustainability (i.e., a self-sustaining population over the long term) under conditions with a 15% chance of catastrophic mortality event per generation and a quasi-extinction threshold of 50 adults at 1% probability of extinction, with 100% of the population exhibiting a stream resident life-history, the adult Rainbow Trout abundance needs to be at least 270,425 adult Rainbow Trout, requiring 14,477 ha of suitable habitat. Estimates for alternative risk scenarios are highly sensitive to the extinction threshold, the probability of catastrophic mortality, and the ratio of individuals from river migrant and stream resident life-history types in the population.

Modélisation du potentiel de rétablissement de la truite arc-en-ciel, *Oncorhynchus mykiss* (populations de la rivière Athabasca)

RÉSUMÉ

Le Comité sur la situation des espèces en péril au Canada (COSEPAC) a évalué les populations de la truite arc-en-ciel (*Oncorhynchus mykiss*) de la rivière Athabasca et déterminé qu'il s'agit d'une espèce menacée au Canada. Nous présentons ci-après la modélisation de la population afin d'étayer l'évaluation du potentiel de rétablissement de l'espèce. Les résultats comprennent une analyse de sensibilité, la détermination des dommages admissibles et l'estimation de la population minimale viable afin d'éclairer l'établissement des cibles de rétablissement pour l'abondance de la population et l'habitat nécessaire. Les analyses démontrent que la dynamique des populations de la truite arc-en-ciel est particulièrement sensible aux perturbations qui ont une incidence sur la survie des individus immatures. On doit réduire au minimum les dommages qui surviennent à ces étapes du cycle de vie pour ne pas mettre en péril la survie et le rétablissement futur des populations de la truite arc-en-ciel de la rivière Athabasca. Afin d'assurer la durabilité démographique (c.-à-d. une population autosuffisante à long terme) dans des conditions où la probabilité qu'un épisode de mortalité catastrophique survienne est de 15 % pour chaque génération et où le seuil de quasi-extinction est de 50 adultes à un taux de probabilité d'extinction de 1 %, avec 100 % de la population résidant dans un cours d'eau et ayant terminé un cycle biologique, l'abondance de la population adulte de la truite arc-en-ciel doit être d'au moins 270 425 individus, ce qui requiert un habitat convenable de 14 477 hectares. Les estimations des autres scénarios de risque sont très sensibles au seuil d'extinction, à la probabilité d'un épisode de mortalité catastrophique et aux proportions d'individus ayant migré et qui résident dans un cours d'eau durant les cycles biologiques dans la population.

INTRODUCTION

Rainbow Trout, *Oncorhynchus mykiss* (Athabasca River populations; hereafter Athabasca Rainbow Trout) was assessed by the Committee on the Status of Endangered Wildlife in Canada (COSEWIC) in 2014 and was designated as Endangered. In accordance with the *Species at Risk Act* (SARA) which mandates the development of strategies for the protection and recovery of species that are at risk of extinction or extirpation from Canada, Fisheries and Oceans Canada (DFO) has developed the recovery potential assessment (RPA) (DFO 2007a, 2007b) as a means of providing information and scientific advice. There are three components to each RPA - an assessment of species status, the scope for recovery, and scenarios for mitigation and alternatives to activities - that are further broken down into 22 elements. This report contributes to components two and three and elements 3, 12, 13, 14, 15, 19, 20, 21, and 22 by identifying population sensitivity and quantifying recovery targets, required habitat, and allowable harm with associated uncertainty for the Athabasca Rainbow Trout. This work is based on a demographic approach developed by Vélez-Espino and Koops (2007, 2009a, 2009b) which determines a population-based recovery target based on long-term population projections.

METHODS

The analysis consisted of four parts:

- (i) information on vital rates was compiled to build projection matrices using uncertainty in life history to represent variation in the life cycle for stochastic simulations.

With these projection matrices:

- (ii) sensitivity of the population growth rate to changes in each vital rate was determined following Vélez-Espino and Koops (2007, 2009a, 2009b);
- (iii) risk of extirpation, time to extirpation, minimum viable population (MVP) and the minimum area for population viability (MAPV; i.e., the amount of suitable habitat required to support the MVP) were estimated; and
- (iv) the effects of allowable harm on the population growth rate were quantified.

SOURCES

Growth patterns and age-specific annual mortality, maturity, and fecundity of Athabasca Rainbow Trout were determined using data from the Tri-Creeks watershed database and COSEWIC (2014). General trends of population growth were identified for several Athabasca drainage waterbodies and current catch per unit area (CPUA) estimates were gathered for individual watersheds. All analyses and simulations were conducted using the statistical program R (R Core Team 2015).

THE MODEL

Using a matrix modelling approach, the life cycle of Athabasca Rainbow Trout was represented with annual projection intervals and by a post-breeding stage-structured projection matrix (Caswell 2001; Figure 1). Elements of the stage-structured matrix include the fecundity coefficient of stage class j (F_j), the stage-specific annual probability of remaining in stage j (P_j) and the transition probability of surviving one stage and moving to the next (G_j).

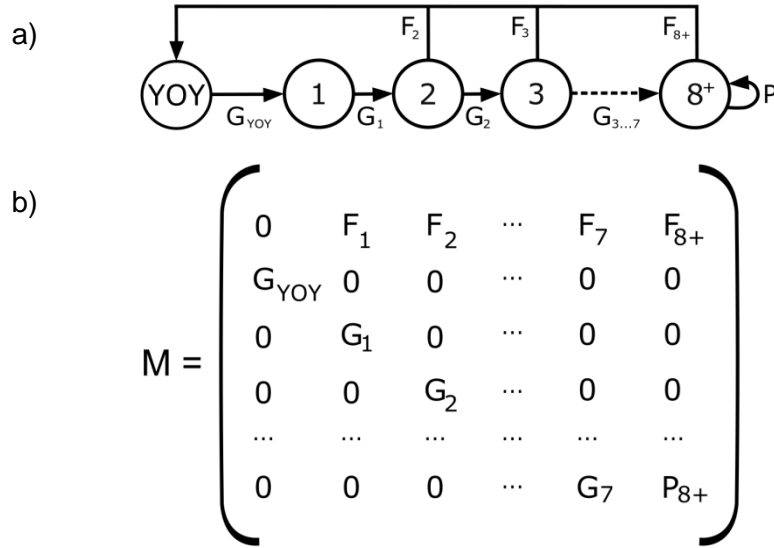

Figure 1. Generalized life cycle (a) and corresponding stage-structured projection matrix (b) used to model the population dynamics of Athabasca Rainbow Trout. F_i represents annual effective fecundities, P_i represents the probability of remaining in the current stage, and G_i represents the probability of moving to the next stage.

Fecundity coefficients (F_j) represent the contribution of an adult in stage class j to the next census of age-0 individuals. Since a post-breeding model is assumed, the coefficient F_j includes the annual survival probability (σ_j), the probability of moving to (G_j) or remaining in the stage (P_j), as well as the stage-specific annual number of female offspring for an individual (f_j) such that

$$F_j = \begin{cases} \sigma_j f_j G_j \\ \sigma_j f_j P_j \end{cases} \text{ (Equation 1)}$$

Where f_j is the product of the average fertility (total annual egg count) for a female of stage j (η_j), the proportion of females in the population (φ , assumed to be 0.5 for Athabasca Rainbow Trout (COSEWIC 2014), the proportion of fish in stage j that reproduce (ρ_j), and the inverse of the average spawning periodicity (T):

$$f_j = \eta_{SR,j} \varphi \rho_j \frac{1}{T} \text{ (Equation 2)}$$

The average fertility (total annual egg count) increases with increasing female size. Athabasca Rainbow Trout populations exhibit one or more of the following two life-history types: river migrant (RM) and stream resident (SR) (COSEWIC 2014). This results in two growth trajectories with fish that remain small through their complete life cycle and fish that grow to large sizes. Individual populations exhibit each growth trajectory separately, or a combination of both. There is no evidence of differential maturity or survival in the two life-history types, however, the larger sized river migrant individuals would necessarily have a higher fertility since fertility increases with increasing body size (see Fecundity). To incorporate this in the model, f_j is weighted by the proportion of the population exhibiting the SR (α) or RM ($1 - \alpha$) life-history types.

$$f_j = \alpha \eta_{SR,j} \varphi \rho_j \frac{1}{T} + (1 - \alpha) \eta_{RM,j} \varphi \rho_j \frac{1}{T} \text{ (Equation 3)}$$

The probability of moving from j to $j+1$ (G_j) is defined as $\sigma_j \gamma_j$ and the probability of surviving and remaining in stage j (P_j) is defined as $\sigma_j (1 - \gamma_j)$. For most stages (YOY – age 7) γ_j was set to one

as no individuals remained in those stages for more than one year. For adult stage, assuming that the age distribution within stages is stable (see Lefkovitch 1965), the term γ_j can be calculated as:

$$\gamma_j = \frac{(\sigma_j/\lambda)^D - (\sigma_j/\lambda)^{D-1}}{(\sigma_j/\lambda)^D - 1} \text{ (Equation 4)}$$

where λ is the largest eigenvalue of the matrix (Caswell 2001) and is set to 1 to represent a population at equilibrium, and D is the duration of the stage (years). D represents the duration between age 8 and the maximum age of the population (t_{max}). The oldest recorded age of Athabasca Rainbow Trout is 10 years (COSEWIC 2014).

PARAMETER ESTIMATES

All model parameters are outlined in Table 1

Individual Growth and Mortality

Estimates of growth for the stream residents were based on length-at-age data for Athabasca Rainbow Trout gathered from the Tri-Creeks watershed database and represent three stream populations, Deerlick Creek, Eunice Creek, and Wampus Creek (Figure 2). The growth curve relates length and age using the formula: $L_t = L_\infty(1 - e^{-k(t-t_0)})$ where L_t is fork length (FL) at age t , t_0 is the hypothetical age at which the fish would have had length 0, L_∞ is the asymptotic size, and k is a growth parameter. Individual data from fish sampled at the mouth of the creek were removed because they were as likely to represent river migrants.

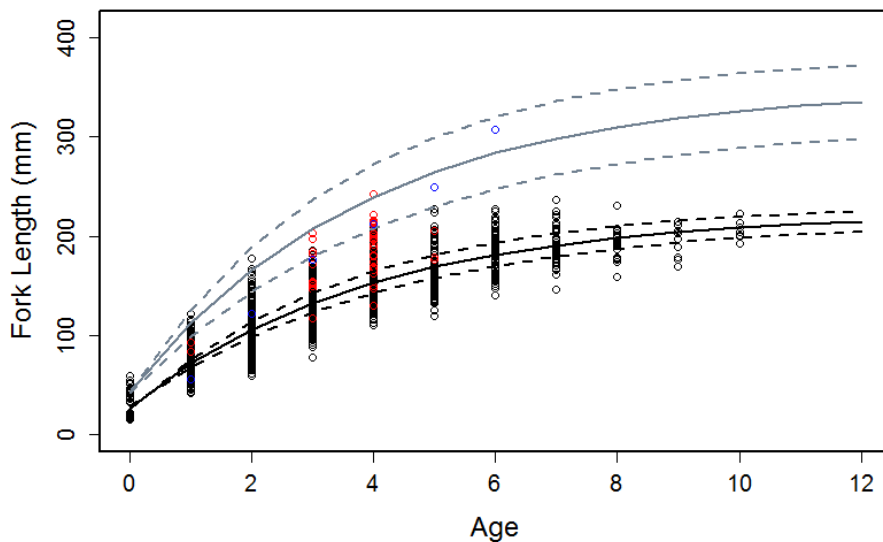

Figure 2. Length-at-age data for Athabasca Rainbow Trout from the Tri-Creeks watershed including fish that were considered stream residents (black open circles) and fish sampled at the mouth of the stream (red open circles), and estimates from McLeod River (blue open circles). Also included is the best fit of the growth curve (solid black line) and 95% confidence intervals (dashed lines). The corresponding model fit and 95% confidence intervals for the river migrant population are shown in grey.

There were minimal length-at-age data available for the river migrants. Estimates of length of river migrants from McLeod River were taken from Dietz (1971), providing an estimate for ages 1 to 7. It could be possible to estimate the growth parameters using data from other rainbow trout populations, however, based on the cumulative size distribution from the sampling (COSEWIC 2014) and the estimates from McLeod River, even the river migrant fish appear smaller than Rainbow Trout in other regions. According to Walters and Post (1993), if feeding rates are proportional to the square of body length, then as density dependence decreases, only the L_{∞} changes (not k or t_0). Assuming the main difference between the RM and SR life-history types is the relaxation of density dependence in rivers, only L_{∞} was changed for the river migrant life-history type. A uniform distribution for L_{∞} for the RM was centered on 350 mm as 95% of fish caught in the larger rivers were less than 350 mm (Figure 2). This corresponded with the data available for river migrant fish sampled in the McLeod River (Dietz 1971; Figure 2).

Age-specific survival was calculated from estimates (mean and standard error) for annual total mortality (A) available for the stream populations in the Tri-Creeks watershed (Sterling 1990). Annual total mortality for the young of year was converted to survival using the relationship $\sigma_{YOY} = e^{-\ln(1-A)}$. Annual mortality is higher for Athabasca Rainbow Trout adults than for juveniles (Sterling 1990). The annual mortality estimates for ages 1 to 3 were averaged and converted to an estimate of juvenile survival (σ_j). Similarly, the annual mortality estimates for ages 7 to 9 were averaged and converted to an estimate of adult survival (σ_A). Age specific survival was then estimated using the proportion of mature individuals (ρ_j) to weight juvenile and adult survival (Figure 3):

$$\sigma_j = \sigma_j (1 - \rho_j) + \sigma_A \rho_j \text{ (Equation 5).}$$

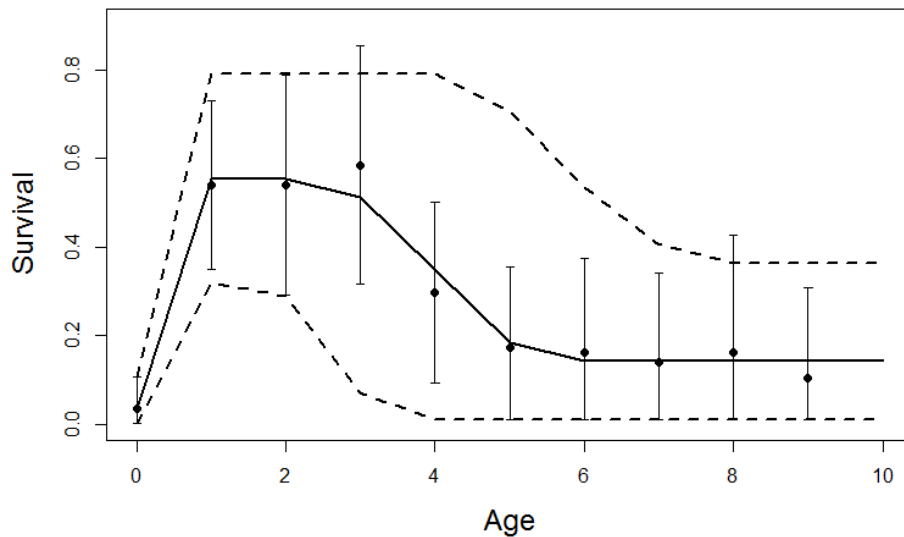

Figure 3. Estimates of age-specific survival for Athabasca Rainbow Trout and associated error for fish sampled in the Tri-Creeks watershed, Alberta along with the mean (solid line) and confidence intervals (dashed lines) of the values used in the model.

Table 1. Range of values, symbols, descriptions, and sources for all parameters used to model Athabasca Rainbow Trout.

	Description	Symbol	Estimate			Source / Reference
			mean	min	max	
Growth	SR asymptotic size (mm)	L_{∞}	224	216	232	Tri-Creeks dataset, (COSEWIC 2014) Figure 2
	RM asymptotic size (mm)	$L_{\infty, RM}$	350	315	385	
	Growth coefficient	k	0.26	0.23	0.28	
	Age at 0 mm	t_0	-0.52	-0.62	-0.43	
Survival	Young-of-the-year (YOY)	σ_{YOY}	0.11	0.003	0.42	(Sterling 1990) Figure 3
	Juvenile	σ_J	0.25	0.01	0.90	
	Adult	σ_A	0.20	0.01	0.60	
Fecundity	Proportion female	ϕ		0.5		(COSEWIC 2014)
	Spawning periodicity	T		1		(COSEWIC 2014)
	Fecundity exponent	ϑ		2.06		
	Fecundity scaler	β		0.008		
	Proportion reproductive	ρ_2	0.05	7.3×10^{-6}	0.1	(Sterling 1990)
		ρ_3	0.35	3.5×10^{-5}	0.70	
		ρ_4	0.50	0.1	1.0	
		ρ_5	0.56	0.20	1.0	
		ρ_6	0.75	0.50	1.0	
	ρ_7	0.95	0.90	1.0		
	ρ_{8+}	1.00	1.00	1.0		
Age	Maximum age	t_{max}		10		(COSEWIC 2014)
Matrix		F_1	0	0	4	
		F_2	18	13	52	
		F_3	112	81	119	
	Effective fecundity ($\lambda = 1$)	F_4	168	128	145	
		F_5	113	121	110	
		F_6	98	125	101	
		F_7	105	110	109	
		F_{8+}	112	109	115	
	Probability of transitioning	G_{1-7}	1	1	1	
		P_{8+}	0.14	0.01	0.33	
Proportion in small trajectory	α	0.95	0.9	1	But see Appendix	
Analysis	Annual population growth rate	λ		various		
	Generic vital rate	v				
	Elasticity	ϵ_v				
	Allowable chronic harm	H_C				
	Allowable transient harm	H_T				
	Minimum viable population	MVP				
Minimum area for population viability	$MAPV$					

Fecundity

Data from the Tri-Creeks watershed (Dietz 1971, Sterling 1990) were used to estimate length specific fecundity, the number of eggs in relation to fork length (mm), by fitting ϑ and β from the following relationship: $E = \vartheta \cdot FL^\beta$ to the data by the method of non-linear least squares. These data represent both stream resident and river migrant fish and the resulting relationship does not appear to differ considerably from previous estimates of Rainbow Trout fecundity measured in a laboratory environment (Scott 1962). The model fit was used to represent both life-history types and uses the best available data for Athabasca Rainbow Trout (Figure 4).

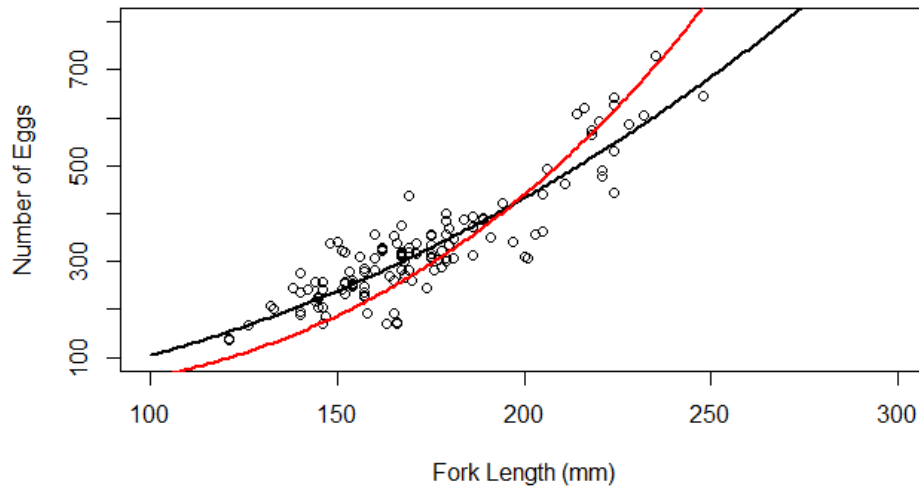

Figure 4. Length specific fecundity data (number of eggs per individual) for Athabasca Rainbow Trout from the Tri-Creeks watershed, Alberta with the resulting model fit used in the model (black line). Shown in red is a model fit using a weight specific fecundity relationship for Rainbow Trout derived from laboratory experiments using fish caught in British Columbia (Scott 1962).

Athabasca Rainbow Trout spawn yearly (COSEWIC 2014) so the spawning periodicity (T) was set to one. The proportion of fish in a stage that reproduce (ρ_i) was estimated from the Tri-Creeks watershed database by fitting a logistic equation to the individual maturity data (1 = mature, 0 = immature) with bootstrapped confidence intervals (Figure 5). Generation time was calculated from the age-specific survival and fecundity estimates as per Caswell (2001).

Population Trajectory

Alberta Environment and Parks has assessed the status of Athabasca Rainbow Trout populations within spatial units each based on an 8-digit Hydrologic Unit Code (HUC). HUCs are a series of hierarchical hydrological units within watershed boundaries. A total of 19 HUC8s were delineated within the range of Athabasca Rainbow Trout. Several metrics were examined to assess the stocks within the HUCs, including metrics of population integrity, productive potential, and threats as part of the Alberta Fish Sustainability Index (FSI) (AEP 2104). The current adult CUPA estimates for each HUC are provided in Table 10 and are based on the best available information gathered in the Alberta Fish Sustainability Index (FSI) dataset (AEP 2014). The COWESIC (2014) estimate of current abundance for Athabasca Rainbow Trout was between 15,000 to 25,000 mature individuals based on the CUPA in the reference streams and the amount of suitable habitat area. Without complete knowledge of the current area of occupancy for each HUC, we estimated abundance based on the CUPA and available habitat

area (see Results), providing a larger estimate of current abundance of 65,175 mature fish (Table 10).

There are limited data on long term population trends for most of the Athabasca Rainbow Trout populations with the exception of the three tributaries in the Tri-Creeks watershed. COSEWIC (2014) gathered CUPA data for tributaries sampled at least twice over the past 15 years to determine annual rate of change (COSEWIC 2014). The range of annual rate of change estimated for all populations, regardless of current CUPA, was used to estimate the mean ($\lambda=0.95$) and standard deviation (0.26) of population growth rates for the sensitivity and allowable harm analyses (COSEWIC 2014).

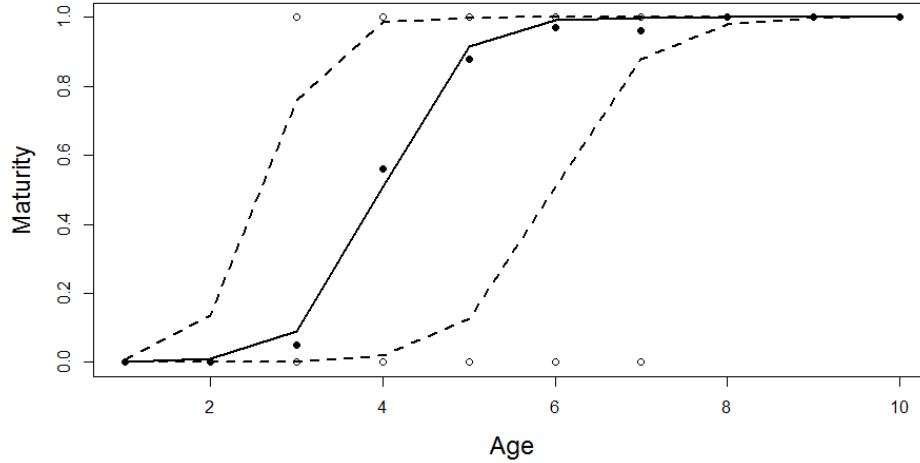

Figure 5. Maturity at age (ρ_j) for individual (open circles: 1= mature, 0= immature) Athabasca Rainbow Trout from the Tri-Creeks watershed in Alberta. The estimates from the COSEWIC (2014) for proportion mature is included for reference (filled circles) along with the logistic model fit (solid line) and bootstrapped 95% confidence intervals (dashed lines).

POPULATION SENSITIVITY

The sensitivity of the population to changes in the environment is determined by the sensitivity of the estimated annual growth rate (λ) to perturbations in the vital rates (v). Annual population growth rate can be estimated as the largest eigenvalue of the projection matrix (Caswell 2001). Model sensitivity is quantified by elasticities which are a measure of the sensitivity of population growth rate to perturbations in vital rate v , and are given by the scaled partial derivatives of λ with respect to the vital rate:

$$\varepsilon_v = \frac{v}{\lambda} \sum_{i,j} \frac{\partial \lambda}{\partial a_{i,j}} \frac{\partial a_{i,j}}{\partial v} \quad (\text{Equation 6})$$

where a_{ij} are the projection matrix elements.

Variation in vital rates was incorporated to determine effects on population responses from demographic perturbations (see Vélez-Espino and Koops 2007). Computer simulations were used to:

- (i) generate 5,000 matrices with values for parameters that contribute to the estimation of vital rates (i.e., L_∞ , k , t_0 , ρ_j and α) drawn from uniform distributions according to the confidence intervals of the estimated parameter values;
- (ii) calculate λ for each matrix and optimize young-of-the-year and juvenile survival to obtain the appropriate geometric mean growth rate ($\lambda = 0.69, 0.95, 1$ or 1.2) for the 5,000 matrices;

-
- (iii) calculate the ε_v for each matrix; and
 - (iv) estimate mean stochastic elasticities and their 95% confidence intervals.

ALLOWABLE HARM

Allowable harm is defined as harm to the population that will not jeopardize population recovery or survival. Chronic harm refers to a negative alteration to a vital rate (survival, fecundity, etc.) that reduces the annual population growth rate permanently or over the long term. Transient harm refers to a one-time removal of individuals such that survival (and therefore population growth rate) is only affected in the year of the removal.

Estimates of allowable chronic harm are based on the population growth rate and are only calculated for populations with positive growth. Allowable chronic harm is estimated assuming a positive growth rate and a minimum acceptable population growth rate of stability ($\lambda = 1$).

Maximum allowable chronic harm (H_c) was estimated analytically as:

$$H = \left(\frac{1}{\varepsilon_v}\right) \left(\frac{1-\lambda}{\lambda}\right) \text{ (Equation 7)}$$

where ε_v is the elasticity of vital rate v , and λ is the growth rate in the absence of additional harm.

The effects of transient harm were modelled as follows:

- (i) annual projection matrices were generated for ten years by randomly drawing vital rates as in the sensitivity analysis;
- (ii) survival of one or all of the stages was reduced for one of the random matrices, simulating a one-time removal of individuals;
- (iii) the geometric mean population growth rates before and after removal were compared over the timeframe considered;
- (iv) this simulation was repeated 5,000 times to create a distribution of changes in population growth rate as a result of removal; and
- (v) rates of removal (number of individuals as a proportion of total abundance) from 0 to all individuals were considered.

Allowable transient harm was defined as a one-time removal of individuals within a time-frame of 10 years that does not reduce the average population growth rate over that time-frame more than a pre-determined amount (see Results). The population growth rate was considered to be “reduced” when the lower confidence bound of the distribution of differences in growth rate pre- and post-removal exceeded the designated amount.

RECOVERY TARGETS

Abundance

Demographic sustainability can be used to identify potential recovery targets for Athabasca Rainbow Trout. Demographic sustainability is related to the concept of a minimum viable population (MVP) (Shaffer 1981), and was defined as the minimum adult population size that results in a desired probability of persistence over 100 years (approximately 20 generations for Athabasca Rainbow Trout).

Since population growth is not sustainable over time, the probability of persistence was simulated for a stable population over the long-term. To achieve stability in the model, young-of-

the-year and juvenile survival rates were optimized to achieve a geometric mean growth rate (in stochastic simulations) of $\lambda = 1$ with the proportion in the stream resident population (α) set to specific values between 0 and 1 to represent the range of possible life-history combinations.

Recovery targets were estimated as follows:

- (i) 50,000 projection matrices were generated by randomly drawing vital rates as in the population sensitivity analysis, based on a geometric mean growth rate of $\lambda = 1$;
- (ii) projection matrices were drawn at random from these to generate 5,000 realizations of population size per time step (i.e., over 100 years);
- (iii) these realizations were used to generate a cumulative distribution function of extinction probability, where a population was said to be extinct if it was reduced to one adult (female) individual;
- (iv) this process was repeated at least five times, giving an average extinction probability per time step. Catastrophic decline in population size, defined as a 50% reduction in abundance, was incorporated into these simulations, and occurred at a probability (P_k) of 0.10 or 0.15 per generation; and
- (v) this process was repeated for several values of the proportion of the population that is stream resident ($\alpha = 0, 0.25, 0.5, 0.75, \text{ and } 1$), as α has been shown to affect population fitness (Vélez-Espino et al. 2013) which could affect the extinction probability.

From these simulations, the minimum number of adults necessary for the desired probability of persistence (see Results) over 100 years was calculated.

Habitat: Minimum Area for Population Viability (MAPV)

Following Velez-Espino et al. (2009), MAPV was estimated as a first order quantification of the amount of habitat required to support a viable population, and calculated for each stage-class in the population as:

$$MAPV_j = MVP_j \cdot API_j \text{ (Equation 8)}$$

where MVP_j is the minimum number of individuals per stage-class required to achieve the desired probability of persistence over 100 years, as estimated for the recovery target; and API_j is the area required per individual in class j . Individuals were distributed among stage classes according to the stable stage distribution, which is represented by the dominant right eigenvector (w) of the mean projection matrix based on the $\lambda = 1$ ($Mw = \lambda \cdot w$) (de Kroon et al. 1986).

A size specific API was estimated by altering an allometry for river environments from (Randall et al. 1995). This general allometry approximates API_j (m^2) for freshwater fishes based on the mean TL in mm of class j :

$$API_j = e^{-a} \cdot TL_j^b \text{ (Equation 9)}$$

with $a = 13.28$ and $b = 2.904$ (Velez-Espino et al. 2009). An Athabasca Rainbow Trout specific version of this relationship was calculated by fitting Equation 9 using benchmark densities.

The benchmark densities for stream resident populations of Athabasca Rainbow Trout were set to 100 age 1+ fish per 0.1 ha, based on historical trends for two reference populations (Deerlick and Wampus creeks) in the Tri-Creeks watershed (COSEWIC 2014). By using the estimated stream resident fork lengths and the stable stage distribution for a stable population ($\lambda = 1$) converted to represent only age 1+ fish, the values for a and b in Equation 9 were fit such that the area required for 100 age 1+ fish was equal to 0.1 ha. The API was then applied to fish in

both life histories. The MAPV for the entire population was estimated by summing the MAPVs for each stage. MAPV was compared to the area available for the Athabasca Rainbow Trout populations.

RESULTS

POPULATION SENSITIVITY

Athabasca Rainbow Trout population growth was most sensitive, on average, to changes in the proportion of stream resident and the survival of young of the year and ages 1 and 2 fish for all population growth rates (Table 2, Figure 6). Sensitivity to fecundity of the stream residents (F_{SR}) and river migrants (F_{RM}) for all population growth rates was highly variable. There was a differential change in sensitivity to stage specific survival between young and old fish as population growth rates increased; sensitivity to survival of the young-of-the-year and ages 1 and 2 increased and sensitivity to survival of ages 4 and greater decreased. Sensitivity to decreasing the probability of transitioning out of the 8+ stage (γ_{8+}) was highly variable and decreased with increasing population growth rates. Sensitivity to decreasing the proportion of the population considered stream residents was highly variable and increased with increasing population growth rates.

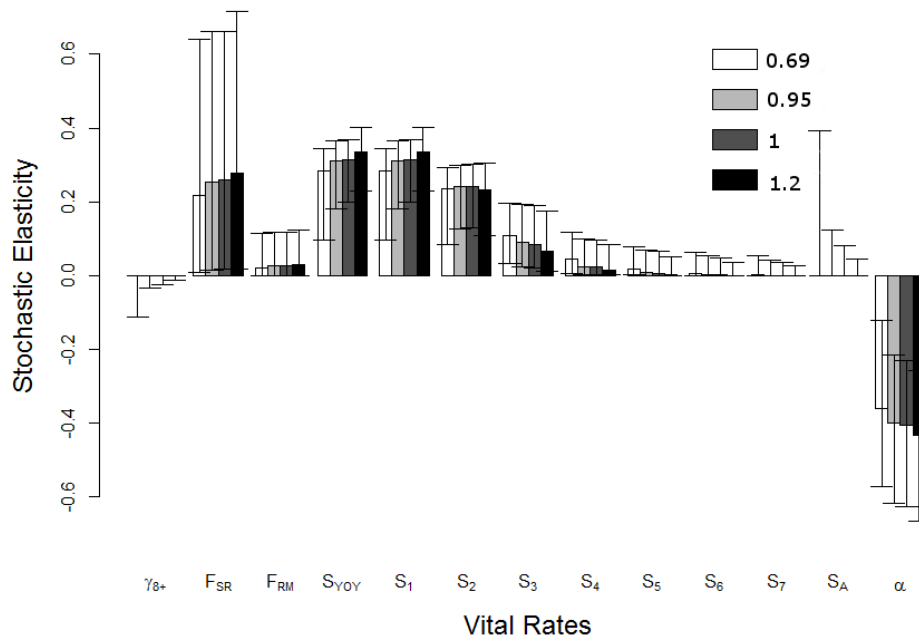

Figure 6. Results of the stochastic perturbations analysis showing elasticities (ϵ_v) of vital rates for Athabasca Rainbow Trout. The vital rates include longevity (i.e., the probability of transitioning out of the 8+ stage [γ_{8+}]), fecundity (F), survival (S) and the proportion of the population in the stream resident life history type (α). Results are for two declining populations ($\lambda = 0.69$ or 0.95), a stable population ($\lambda = 1$), and a population growing with positive growth ($\lambda = 1.2$). Exact values are listed in Table 2.

Table 2. Summary of elasticities of Athabasca Rainbow Trout vital rates (ε_v) at positive population growth ($\lambda = 1.2$), a stable population ($\lambda = 1$) and two declining populations ($\lambda = 0.95$ and 0.69). Shown are elasticities for: the probability of transitioning out of the 8+ stage (γ_{8+}), fecundity of the stream residents (F_{SR}) and the river migrants (F_{RM}), annual survival of YOY (σ_{YOY}) and ages 1-8+ ($\sigma_1 - \sigma_{8+}$), and probability of belonging to the stream resident life history type.

Growing Population ($\lambda = 1.2$)

Vital Rate	γ_{8+}	F_{SR}	F_{RM}	σ_{YOY}	σ_1	σ_2	σ_3	σ_4	σ_5	σ_6	σ_7	σ_{8+}	α
Stochastic Mean	-2.2×10^{-6}	0.28	0.03	0.34	0.34	0.23	0.07	0.01	3.1×10^{-3}	6.0×10^{-4}	8.4×10^{-5}	1.0×10^{-5}	-0.43
Lower Confidence	-0.01	0.02	7.7×10^{-4}	0.23	0.23	0.11	0.01	2.0×10^{-3}	2.9×10^{-4}	2.7×10^{-5}	1.2×10^{-6}	3.5×10^{-8}	-0.67
Upper Confidence	-1.6×10^{-9}	0.72	0.12	0.40	0.40	0.31	0.18	0.08	0.05	0.04	0.03	0.04	-0.26

Stable Population ($\lambda = 1$)

Vital Rate:	γ_{8+}	F_{SR}	F_{RM}	σ_{YOY}	σ_1	σ_2	σ_3	σ_4	σ_5	σ_6	σ_7	σ_{8+}	α
Stochastic Mean	-8.6×10^{-6}	0.26	0.03	0.31	0.31	0.24	0.09	0.02	0.01	1.6×10^{-6}	2.7×10^{-4}	4.0×10^{-5}	-0.41
Lower Confidence	-0.02	0.02	6.4×10^{-4}	0.20	0.20	0.13	0.02	3.5×10^{-3}	6.4×10^{-3}	6.8×10^{-4}	3.5×10^{-5}	1.1×10^{-7}	-0.63
Upper Confidence	-4.6×10^{-9}	0.66	0.12	0.37	0.37	0.30	0.19	0.10	0.06	0.05	0.04	0.08	-0.23

Declining Population ($\lambda = 0.95$)

Vital Rate:	γ_{8+}	F_{SR}	F_{RM}	σ_{YOY}	σ_1	σ_2	σ_3	σ_4	σ_5	σ_6	σ_7	σ_{8+}	α
Stochastic Mean	-1.1×10^{-5}	0.25	0.03	0.31	0.31	0.24	0.09	0.02	0.01	1.8×10^{-3}	3.2×10^{-4}	5.1×10^{-5}	-0.40
Lower Confidence	-0.03	0.02	6.8×10^{-4}	0.18	0.18	0.13	0.02	3.8×10^{-3}	7.1×10^{-4}	8.3×10^{-5}	4.5×10^{-6}	1.6×10^{-7}	-0.62
Upper Confidence	-7.6×10^{-9}	0.66	0.12	0.37	0.37	0.30	0.19	0.10	0.07	0.05	0.04	0.12	-0.21

Declining Population ($\lambda = 0.69$)

Vital Rate:	γ_{8+}	F_{SR}	F_{RM}	σ_{YOY}	σ_1	σ_2	σ_3	σ_4	σ_5	σ_6	σ_7	σ_{8+}	α
Stochastic Mean	-6.5×10^{-5}	0.22	0.02	0.28	0.28	0.24	0.11	0.04	0.02	0.01	1.3×10^{-3}	3.0×10^{-4}	-0.36
Lower Confidence	-0.11	0.01	4.1×10^{-4}	0.10	0.10	0.08	0.03	0.01	1.4×10^{-3}	1.9×10^{-4}	1.3×10^{-5}	6.2×10^{-7}	-0.57
Upper Confidence	-2.9×10^{-8}	0.64	0.11	0.35	0.35	0.29	0.20	0.12	0.08	0.06	0.05	0.39	-0.12

ALLOWABLE HARM

Allowable Chronic Harm

From a precautionary perspective, the upper 95% confidence level is applied for allowable harm for positive elasticities. Our results suggest that the Athabasca Rainbow Trout population would have the lowest allowable harm for fecundity of the stream resident life history type with a maximum allowable reduction of 23%. There would also be a limit to the allowable harm to the survival of the young-of-the-year and ages 1 to 3, with a maximum allowable reduction of 41%, 41%, 55%, and 95%, respectively (Table 3). The population is also sensitive to increasing the proportion of the population that are stream residents (i.e., the population is sensitive to harm to the river migrants).

Allowable harm values that do not fall between 0 and -1 (or 0 and 1 in the case of parameters that would increase λ if decreased, i.e., γ_{8+}) indicate that the population growth rate is not sensitive to changes in this vital rate alone if all other vital rates are held constant.

Table 3. A summary of Athabasca Rainbow Trout allowable chronic harm (as a proportion of the vital rate, H_c) for a population with positive growth ($\lambda = 1.2$). Shown are allowable harm for: probability of transitioning out of the 8+ stage (γ_{8+}), fecundity of the stream residents (F_{SR}) and the river migrants (F_{RM}), annual survival of YOY (σ_{YOY}) and ages 1-8+ ($\sigma_1 - \sigma_{8+}$), and probability of belonging to the stream resident life history type.

Vital Rate	γ_{8+}	F_{SR}	F_{RM}	σ_{YOY}	σ_1	σ_2	σ_3	σ_4	σ_5	σ_6	σ_7	σ_{8+}	α
Stochastic Mean	7.57×10^4	-0.60	-5.80	-0.5	-0.5	-0.72	-2.55	-12.23	-53.47	-279.53	-1.98×10^3	-1.70×10^4	0.38
Lower Confidence	13.03	-8.79	-216.8	-0.72	-0.72	-1.54	-13.22	-85.43	-583.40	-6.3×10^3	-1.4×10^5	-4.8×10^6	0.25
Upper Confidence	1.03×10^8	-0.23	-1.35	-0.41	-0.41	-0.55	-0.95	-2.00	-3.22	-4.49	-6.33	-3.83	0.64

Allowable chronic harm on survival would be lower if ages are combined. It is often difficult to distinguish between individual ages. Elasticities are additive, so if we were to consider harm on ages 1–4 combined, the allowable chronic harm would be 17% (Table 4), which is much lower than considering them individually.

Allowable chronic harm would be lower if the population is growing at a slower rate. Allowable chronic harm for a population with a positive growth rate (λ^+) that is lower than the maximum population growth rate ($\lambda_{max} > \lambda^+ > 1$) can be approximated with Equation 7 by using the λ^+ along with the elasticities from a growing population ($\lambda = \lambda_{max}$) in Table 2. If human activities are such that harm exceeds just one of these thresholds, the future persistence of populations is likely to be compromised. In addition, simulations suggest that recovery time can be severely delayed by any level of harm within the maximum allowable harm suggested in Tables 3 and 4 (Young and Koops 2011).

Table 4. A summary of Athabasca Rainbow Trout allowable chronic harm (as a proportion of the vital rate, H_c) for a population with positive growth ($\lambda = 1.2$). Shown are allowable harm for: probability of transitioning out of the 8+ stage (γ_{8+}), fecundity of the stream residents (F_{SR}) and the river migrants (F_{RM}), annual survival of YOY (σ_{YOY}), annual survival of ages 1 to 4 (σ_{1-4}), annual survival of ages 5+ (σ_{5+}), and probability of belonging to the stream resident life history type.

Vital Rate	γ_{8+}	F_{SR}	F_{RM}	σ_{YOY}	σ_{1-4}	σ_{5+}	α
Stochastic mean	7.57×10^4	-0.60	-5.80	-0.50	-0.26	-43.77	0.38
Lower Confidence	13.03	-8.79	-216.84	-0.72	-0.47	-532.07	0.25
Upper Confidence	1.03×10^8	-0.23	-1.35	-0.41	-0.17	-1.05	0.64

Allowable Transient Harm

Allowable transient harm (allowable one time removal, performed no more frequently than once every 10 years) can be extracted from Figures 7 and 8 by determining the percent removal that is associated with an acceptable reduction in the population growth rate over that time period (following the curve for the life stage being removed). We suggest that the upper confidence bounds be used, as negative values in the upper confidence bound represent a change in the population growth rate beyond that which might result simply from environmental stochasticity.

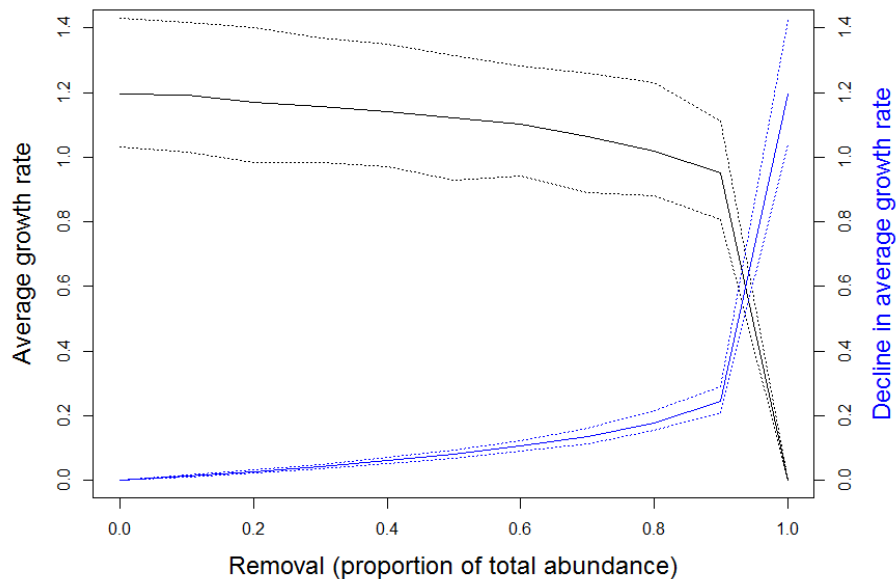

Figure 7. The average growth rate (black) and decline in average growth rate (blue) for an Athabasca Rainbow Trout population growing at $\lambda = 1.2$ over 10 years, as a function of the percent of individuals removed from the population in one of 10 years. Means (solid lines), bootstrap 95% confidence intervals (dotted lines) are shown. Results are for removal of **all** stages.

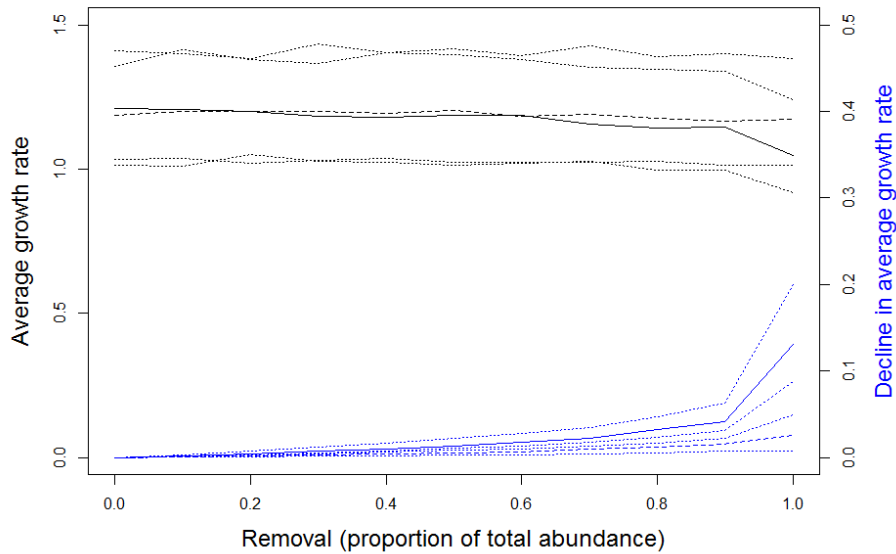

Figure 8. The average growth rate (black) and decline in average growth rate (blue) for an Athabasca Rainbow Trout population growing at $\lambda = 1.2$ over 10 years, as a function of the percent of individuals removed from the population in one of 10 years. For simplicity in presentation, similar stages were averaged: the average of young-of-the-year, age 1 and 2 (solid lines), the average of ages 3 to 8+ (dashed lines) and bootstrap 95% confidence intervals (dotted lines) are shown.

Allowable transient harm may also differ depending on the population growth rate; a growing population may be able to sustain a larger removal without going into decline than a stable population. For example, if an acceptable change in the population growth rate is 0.05 for a stable population, the allowable one-time removal every 10 years is ~35% of all individuals. An acceptable change in population growth rate for a population growing at a rate of $\lambda = 1.2$ may be 0.06, which would yield the same allowable removal of ~35% of all individuals once every 10 years (Figure 9).

The figures here represent removal rates (i.e., a proportion of the population). Absolute numbers can be determined from the removal rates by multiplying by the population abundance for the appropriate life stage. Absolute numbers of individuals can also be calculated deterministically (i.e., ignoring environmental variation) given the population abundance (N_0), acceptable change in mean population growth rate ($\Delta\lambda$), and the survival rate of stage class j (σ_j):

$$h_j = \Delta\lambda N_0 \sigma_j \text{ (Equation 10)}$$

RECOVERY TARGETS

Recovery Efforts

For populations with a declining population ($\lambda < 1$), the elasticities can be used to calculate the amount of change to a vital rate required to increase the population growth rate to 1 (stable). From a precautionary perspective, lower 95% confidence levels are applied when the elasticities are positive, and the upper 95% confidence levels are applied when the elasticities are negative. As outlined in Table 5, an increase in the survival rates σ_{YOY} or σ_{1-4} of 29% or 16%, respectively, could increase λ from 0.95 to 1. An increase in the survival rates σ_{YOY} or σ_{1-4} of 54% or 24% respectively, could increase λ from 0.69 to 1. Values that do not fall between 0 and

1 (or 0 and -1 in the case of parameters that would decrease λ if increased, i.e., α) indicate that the population is not sufficiently sensitive to changes in these vital rates at the specified λ to achieve survival or recovery if all other vital rates are held constant. No amount of change to that individual vital rate could bring the population growth rate up to one.

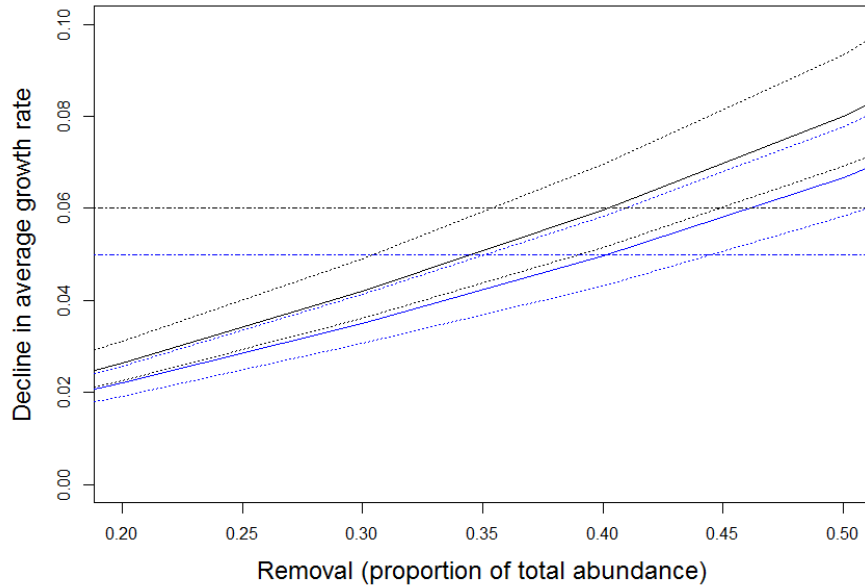

Figure 9. Decline in average growth rate associated with removals of the total abundance for all stages in an Athabasca Rainbow Trout population with $\lambda = 1.2$ (black) or $\lambda = 1.0$ (blue) with 95% confidence intervals (dotted lines) along with potentially acceptable declines in average growth rate associated with stable (0.05, blue dashed line) and increasing (0.06, black dashed line) growth rates with the same associated removal of total abundance (~ 0.35).

Table 5. The proportional change of population vital rates required to raise the population growth rate (λ) to 1 (stable) from a declining λ . Highlighted in grey are vital rates that, if changed by the specified amount, could theoretically raise λ to 1 even if all other rates were held constant.

Declining Population ($\lambda = 0.95$)

Vital Rate	F_{SR}	F_{RM}	σ_{YOY}	σ_{1-4}	σ_{5+}	α
Stochastic mean	0.21	2.05	0.17	0.08	5.38	-0.13
Lower Confidence	3.32	77.54	0.29	0.16	66.39	-0.09
Upper Confidence	0.08	0.44	0.14	0.06	0.18	-0.25

Declining Population ($\lambda = 0.69$)

Vital Rate	F_{SR}	F_{RM}	σ_{YOY}	σ_{1-4}	σ_{5+}	α
Stochastic mean	0.24	2.43	0.19	0.08	2.18	-0.15
Lower Confidence	5.79	127.54	0.54	0.24	32.55	-0.09
Upper Confidence	0.08	0.47	0.15	0.06	0.09	-0.43

Abundance Targets (MVP)

Probability of extinction decreases as a power function of population size (Appendix 2). Functions of the form $y = a \times b$ were fitted, using non-linear least squares, to the simulated extinction probabilities for each catastrophe scenario.

While choosing a larger recovery target will result in a lower risk of extinction, there are also costs associated with an increased target (e.g., increased recovery effort, longer time to recovery, etc.). When determining MVP from the fitted power curves, we attempted to balance the benefit of reduced extinction risk and the cost of increased recovery effort with the following algorithm:

- (i) we assumed that the maximum allowable risk of extinction is 10% based on COSEWIC's quantitative criteria (E) that a risk of extinction greater than or equal to 10% within 100 years constitutes Threatened status. We define a maximum MVP (i.e., maximum feasible effort) to be the population that would result in a 0.1% probability of extinction, as this is the most stringent criteria in the literature;
- (ii) using these as boundaries, we calculate the average decrease in probability of extinction per individual increase in population size; and
- (iii) we choose as MVP the population size that would result in this average (i.e., the point on the power curve at which the slope equals the average % decrease in extinction risk per increase in target). This represents the point between the upper and lower boundaries where the reduction in extinction risk per investment in recovery is maximized.

Calculated in this way, the reduction in extinction risk per investment in recovery is maximized at approximately 1% probability of extinction. MVP at 1% probability of extinction, and extinction threshold of two adults after 100 years, and 15% risk of catastrophe, ranged from 866 adults to 1,422 adults depending on the proportion of the population that was considered stream residents (α). We observed that assuming a higher quasi-extinction threshold (i.e., if the population is considered effectively extinct before it declines to 1 female) results in large increases in MVP. For example, if the quasi-extinction threshold is increased to 50 adults, and the chance of catastrophe is 15% per generation, the mean MVP increases from 136,000 to 270,000. Thus, if the true extinction threshold is greater than 1 adult female, larger recovery targets should be considered.

Table 6 presents the MVP estimates for a range of extinction probabilities, probabilities of catastrophes, and extinction thresholds. The values for a and b included in Table 6 can be used to determine the probability of extinction for any abundance estimate by substituting them in the equation: $P_{ext} = aN^b$.

Table 6 can also be used to determine how the MVP or probability of extinction might be affected if any of the variables considered were changed. For example, if catastrophes occur at 15% per generation and the recovery target is set based on an assumption that catastrophes occur at 10% per generation, the MVP could be up to 7.5 times higher (for 0.1% probability of extinction and a threshold of 2 adults) and was on average 2.4 times higher across all scenarios.

The MVP depends on the proportion of the population that is considered stream resident (α). The highest MVP estimates occurred when the population was evenly split between stream residents and river migrants, or when the population was either completely stream residents or river migrants (see Appendix 3). Intermediate values of α (0.25 and 0.75) had the lowest MVP estimates.

Table 6. Estimates of the minimum viable population (MVP) and the respective parameters (a,b) for the equation to estimate the probability of extinction (P_{ext}) for the extinction thresholds of 2 and 50 adults, and the probability of catastrophe per generation of 10% and 15%. Results are broken down for populations with the proportion of the population that are stream residents (α) of 0.9, 0.95 and 1.

$\alpha = 0.9$

Extinction Threshold	2		50	
	10	15	10	15
Probability of Catastrophe				
<i>a</i>	0.13	0.14	0.32	0.40
<i>b</i>	-0.45	-0.38	-0.33	-0.31
0.1% Probability of Extinction	55,260	414,945	39,050,092	224,338,597
1% Probability of Extinction	318	1,034	36,362	136,794
3% Probability of Extinction	27	59	1,302	4,001
5% Probability of Extinction	9	16	277	775
7.5% Probability of Extinction	4	5	81	210
10% Probability of Extinction	2	3	34	83

$\alpha = 0.95$

Extinction Threshold	2		50	
	10	15	10	15
Probability of Catastrophe				
<i>a</i>	0.13	0.16	0.34	0.39
<i>b</i>	-0.40	-0.41	-0.33	-0.31
0.1% Probability of Extinction	183,945	245,061	61,060,008	276,787,296
1% Probability of Extinction	567	866	51,295	152,306
3% Probability of Extinction	36	59	1,748	4,242
5% Probability of Extinction	10	17	363	802
7.5% Probability of Extinction	4	6	104	214
10% Probability of Extinction	2	3	43	84

$\alpha = 1$

Extinction Threshold	2		50	
	10	15	10	15
Probability of Catastrophe				
<i>a</i>	0.14	0.13	0.28	0.36
<i>b</i>	-0.43	-0.39	-0.31	-0.30
0.1% Probability of Extinction	166,520	489,236	207,317,375	549,823,287
1% Probability of Extinction	818	1,422	112,060	270,425
3% Probability of Extinction	65	88	3,095	7,139
5% Probability of Extinction	20	24	583	1,317
7.5% Probability of Extinction	8	9	155	344
10% Probability of Extinction	4	4	61	133

The current population size for each HUC was estimated based on the best estimate of CPUA and the estimated occupied area (see Habitat Targets, Table 10). The average current probability of extinction, based on the most conservative scenario with a probability of catastrophe of 15% and an extinction threshold of 50 adults, for each HUC is 4.7% and ranges

from 2% to 20% (Table 7) depending on the proportion of the population that is considered a stream resident (α). It is important to note that these estimates are based on a population that is stable ($\lambda = 1$), the population growth rates of the HUC populations are unknown, and if they are in decline, the probability of extinction would be greater.

Table 7. The current probability of extinction (P_{ext}) of Athabasca Rainbow Trout for each HUC based on the CPUA and the available habitat in the occupied range, for a probability of catastrophe of 15% and an extinction threshold of 50 adults assuming the populations are stable ($\lambda=1$).

HUC 8	Estimated Adult Abundance	$\alpha= 0.9$	$\alpha= 0.95$	$\alpha=1$
17010102	6205	0.03	0.03	0.03
17010103	0			
17010104	3787	0.03	0.03	0.03
17010105	10	0.20	0.19	0.18
17010106	0			
17010201	0			
17010301	4587	0.03	0.03	0.08
17010302	5263	0.03	0.03	0.03
17010401	9291	0.02	0.02	0.02
17010501	3094	0.03	0.03	0.03
17010601	2615	0.03	0.03	0.03
17010602	45	0.12	0.12	0.12
17010603	2322	0.04	0.04	0.04
17020101	6781	0.03	0.03	0.03
17020102	9497	0.02	0.02	0.02
17020201	4206	0.03	0.03	0.03
17020202	2744	0.03	0.03	0.03
17020203	2612	0.03	0.03	0.03
17020204	2116	0.04	0.04	0.04

Habitat Targets (MAPV)

The stable stage distribution of Athabasca Rainbow Trout for stream resident and river migrant population types is listed in Table 8. Note that this distribution assumes a post-breeding census such that the YOY class consists of individuals that are newly hatched; the age 1 class have just had their first birthday, and so on. To be conservative, the MAPV was calculated with an extinction risk of 1%.

MAPV ranged from 18 ha to 24,121 ha (Table 9). The MAPV that corresponds to a probability of catastrophe of 15%, an extinction threshold of 50 adults, and an extinction risk of 1% is the most conservative scenario. These MAPV estimates assume that each individual requires the area (API) listed in Table 8 and does not account for any overlapping of individual habitats (sharing) that may occur. It is important to note that this area is based on an allometry of fish density per fish size and does not include any additional space requirements for the completion of life stages.

Table 8. For Athabasca Rainbow Trout with the proportion of the population that is a stream resident (α) of 0.5: the stable stage distribution; the proportion of the age 1+ population at each stage; the average fish length, area per individual (API) and the average area for 100 fish for stream residents (SR); and the average fish length and area per individual (API) for river migrants (RM).

Stage	SSD	Age1+ SSD	Stream Resident			River Migrant	
			Length (mm)	API (m ²)	Area Per 100 fish (m ²)	Length (mm)	API (m ²)
YOY	0.99		27.68	1.14		43.29	2.28
1	5.4x10 ⁻³	0.47	71.87	5.00	232.89	112.39	10.02
2	2.4x10 ⁻³	0.21	106.11	9.17	192.01	165.93	18.36
3	1.2x10 ⁻³	0.11	132.63	12.96	137.29	207.40	25.97
4	7.6x10 ⁻⁴	0.07	153.17	16.21	106.89	239.53	32.48
5	5.3x10 ⁻⁴	0.05	169.10	18.91	87.74	264.42	37.87
6	4.2x10 ⁻⁴	0.04	181.42	21.09	77.17	283.70	42.24
7	3.8x10 ⁻⁴	0.03	190.97	22.84	75.71	298.64	45.75
8	4.3x10 ⁻⁴	0.04	198.37	24.23	90.30	310.21	48.53

Table 9. The minimum area for population viability (MAPV, reported in ha) for Athabasca Rainbow Trout populations with an extinction threshold of either 2 or 50 adults, a probability of catastrophe per generation of 10% or 15%, and the proportion of the population that is a stream resident (α) of 0, 0.25, 0.5, 0.75, **0.9**, **0.95** and **1** at 1% probability of extinction.

Extinction Threshold Probability of Catastrophe	2		50	
	10	15	10	15
$\alpha = 0$	56.54	291.47	4,848.32	23,187.50
$\alpha = 0.25$	32.39	284.08	3,027.82	14,396.49
$\alpha = 0.5$	70.83	365.48	7,507.02	24,121.02
$\alpha = 0.75$	40.95	80.91	2,980.54	9,366.57
$\alpha = 0.9$	33.39	51.00	3,020.64	8,968.93
$\alpha = 0.95$	17.87	58.12	2,043.91	7,689.21
$\alpha = 1$	43.74	76.07	5,998.82	14,476.53

Table 10. Estimates of the current native adult abundance (using the average CPUA [adults/0.1ha]) and the potential adult abundance (using the benchmark of 100 age1+ individuals/0.1 ha with 23% adults) for each HUC 8 were calculated using the occupied stream length with the CPUA reduced to 20% for the less ideal streams of order 5 (Alberta Fish Sustainability Index [FSI] dataset, AEP [2014]). In addition, the potential probability of extinction (P_{ext}) of Athabasca Rainbow Trout for each HUC based on the potential adult abundance, for a probability of catastrophe of 15% and an extinction threshold of 50 adults assuming the populations are stable ($\lambda = 1$) for populations with 100% stream residents.

HUC 8	Average CPUA (adults/0.1ha)	Occupied Stream (order 2-4) Area (ha)	Occupied Stream (order 5) Area (ha)	Estimated Adult Abundance	Potential Adult Abundance (23 adults/0.1ha)	Potential P_{ext} ($\alpha= 1$)
17010102	6.00	103.41		6205	23,785	0.02
17010103	0.00	29.72		0	6,835	0.03
17010104	7.00	54.10		3787	12,444	0.02
17010105	0.80	0	6.09	10	280	0.07
17010106	0.00	41.04	13.86	0	10,077	0.02
17010201	0.00	33.87	48.18	0	10,007	0.02
17010301	1.80	222.65	160.85	4587	58,608	0.01
17010302	2.90	147.50	169.95	5263	41,743	0.01
17010401	4.10	226.61		9291	52,121	0.01
17010501	1.80	171.90		3094	39,537	0.02
17010601	1.80	119.11	130.90	2615	33,416	0.02
17010602	1.70	2.63		45	604	0.05
17010603	1.80	129.02		2322	29,675	0.02
17020101	1.88	347.98	63.59	6781	82,961	0.01
17020102	3.40	245.19	170.60	9497	64,242	0.01
17020201	5.60	75.10		4206	17,273	0.02
17020202	3.00	83.15	41.60	2744	21,038	0.02
17020203	3.00	64.81	111.22	2612	20,022	0.02
17020204	3.30	55.88	41.24	2116	14,749	0.02

The occupied area within the current extent of occupancy was calculated by multiplying an estimate of the available stream length in the current extent of occupancy calculated for each stream order (1-5) (Alberta Fish Sustainability Index [FSI] dataset, AEP [2014]) by the average width for a stream of the respective order. The total available area within the current extent of occupancy based on these calculations is 2,153 ha for stream orders 2–4 and 958 ha for stream order 5 (Table 10). If certain areas of the current available habitat are deemed partially unsuitable, the total minimum required area should be increased. Based on the 23 adults/0.1ha benchmark, 5 out of 19 HUCs could achieve the $P_{\text{ext}} = 1\%$ based on available habitat. The remaining 14 HUCs could achieve P_{ext} of 2–7%.

DISCUSSION

Element 3: Estimate the current or recent life-history parameters for Athabasca Rainbow Trout

The best available data were assembled to provide life-history parameters for Athabasca Rainbow Trout. The range of values for each life history parameter used in the modelling are presented in Table 1. Details regarding how the parameters were estimated and source data used are outlined in the Methods section of this report.

Element 12: Propose candidate abundance and distribution target(s) for recovery

Alberta Sustainable Resource Development and Alberta Conservation Association (2009) established undisturbed benchmarks of 100 fish/0.1 ha which translates to 23 adults/0.1 ha (age 4+ fish, Table 8), based on abundance estimates for unfished reference streams in the Tri-Creeks Experimental Watershed. A target of 50 fish per 0.1 ha was suggested to provide resilience to natural factors (medium risk).

The minimum viable population (MVP) based on an extinction threshold of 50 adults (total abundance) in 100 years with a 15% risk of catastrophe per generation for Athabasca Rainbow Trout ranged from 136,000 to 270,000 adults at a 1% probability of extinction depending on the proportion of the population that is considered stream resident. In comparison to the benchmark of 23 adult fish/0.1 ha, the average adult density for the most conservative MVP's, would be 119 adult fish/0.1 ha with a range of 30 to 283 adult fish/0.1 ha across HUCs, for all HUCs with greater than 15 ha of available habitat. The average estimate based on MVP is higher than the previously set benchmark based on historical densities. If historical densities represent maximum densities, then more habitat would be required to support MVP.

We emphasize that the choice of recovery target is not limited to the scenarios presented. Required adult population sizes can be calculated for any alternative probability of extinction using one of the extinction equations depending on which risk scenario (probability of catastrophe and extinction threshold) best represents Athabasca Rainbow Trout and what level of risk is considered acceptable.

According to Reed et al. (2003), catastrophic events (a one-time decline in abundance of 50% or more) occur at a probability of 0.14 per generation in vertebrates. It is uncertain at what frequency catastrophic events occur for Athabasca Rainbow Trout. We therefore modelled recovery targets assuming a stable population with the most conservative catastrophe scenario, based on Reed et al. (2003), of 15%. The underlying pattern of decline will need to be determined to ensure the persistence of Athabasca Rainbow Trout.

We also emphasize that recovery targets based on MVP can be easily misinterpreted as a reference point for exploitation or allowable harm. A recovery target is neither of these things because it pertains exclusively to a minimum abundance level for which the probability of long-

term persistence within a recovery framework is high. Therefore, abundance-based recovery targets are particularly applicable to populations that are below this threshold, and are useful for optimizing efforts and resources by selecting those populations that are in the greatest need of recovery. We stress that these MVP targets refer to adult numbers only. If juveniles are being included in abundance estimates, then the MVP must include these age classes as well.

Element 13: Project expected population trajectories over a scientifically reasonable time frame (minimum 10 years), and trajectories over to the potential recovery target(s), given current Athabasca Rainbow Trout population dynamics parameters.

A best case scenario for the population trajectories at the upper 95% confidence interval of the observed population growth rate ($\lambda = 1.2$) is shown in Appendix 1. At this growth rate, most HUCs could reach the potential abundance within 10–15 years, based on the benchmark of 23 adult fish/0.1 ha if connectivity between HUCs is zero. For the most conservative MVP of 270,000 adult fish, only two of the HUCs would reach the MVP within 20 years.

Element 14: Provide advice on the degree to which supply of suitable habitat meets the demands of the species both at present and when the species reaches the potential recovery target(s) identified in element 12.

Currently Athabasca Rainbow Trout populations appear to be at lower densities than the current supply of habitat can support when compared to historical densities. There is however a significant risk to the suitability of this habitat with selenium contamination from mountain coal mines and other forms of habitat degradation (COSEWIC 2014).

To obtain the minimum viable population of 270,000 adult fish for the extinction threshold of 50 adults in 100 years with a risk of catastrophe of 15% per generation at $\alpha = 1$, the minimum required habitat is 14,476.53 ha. None of the individual populations would have sufficient area to meet the requirements of the most conservative scenario if the HUCs are to be considered isolated. There is, however, sufficient habitat to reduce the risk of extinction below 2% in 100 years for 16 HUCs if abundance could be recovered to historical benchmarks (23 adults/0.1 ha).

Element 15: Assess the probability that the potential recovery target(s) can be achieved under the current rates of population dynamics, and how that probability would vary with different mortality (especially lower) and productivity (especially higher) parameters.

Many of the HUC 8 population trends are showing decline, meaning that there is a low probability that at the current rates of population dynamics, the potential recovery targets can be achieved. Sensitivity analysis suggests that the population is most sensitive to survival at the young ages (YOY, age 1–2), decreasing mortality for those ages would have the greatest impact on the probability of achieving potential recovery targets. A population with $\lambda = 0.95$ can be increased to a $\lambda = 1$, stable, if there was a proportional change in the young-of-the-year and ages 1–4 survival of 0.29 and 0.16, respectively. It would take a larger proportional change to increase the growth rate if the population growth rate was lower than 0.95 or if a positive growth rate was preferred (e.g., $\lambda = 1.2$) and it may not be possible if only individual vital rates were increased.

Element 19: Estimate the reduction in mortality rate expected by each of the mitigation measures or alternatives in element 16 and the increase in productivity or survivorship associated with each measure in element 17.

No clear links have been identified between the mitigation measures and Athabasca Rainbow Trout mortality rates and productivity.

Element 20: Project expected population trajectory (and uncertainties) over a scientifically reasonable time frame and to the time of reaching recovery targets, given

mortality rates and productivities associated with the specific measures identified for exploration in element 19. Include those that provide as high a probability of survivorship and recovery as possible for biologically realistic parameter values.

Without a direct link between mitigation measures, we are unable to provide this information. See Element 13 for a best case scenario for the time to achieve potential population benchmarks and MVPs.

Element 21: Recommend parameter values for population productivity and starting mortality rates and, where necessary, specialized features of population models that would be required to allow exploration of additional scenarios as part of the assessment of economic, social, and cultural impacts in support of the listing process.

The parameter values presented in Table 1 are based on the best available data for this population and should be used for any future population modelling. The degree of connectivity between and within HUCs should be taken into consideration when exploring additional scenarios as that will have a large effect on the minimum viable population. It is recommended that the value of 1 is used for the proportion of the population that is a stream resident (α) since this generated the most conservative results within the range that is most likely (i.e. 90-100%).

Element 22: Evaluate maximum human-induced mortality and habitat destruction that the species can sustain without jeopardizing its survival or recovery.

For a population that is experiencing positive growth, our results show that to avoid jeopardizing the survival and future recovery of Athabasca Rainbow Trout, human-induced harm to fecundity and the annual survival of juveniles should be minimal. Maximum allowable harm for fecundity of the stream resident life history type would be 23% (Table 3). The allowable harm to the survival of young of the year or juveniles is 41% and 17%, respectively (Table 3). If more than one vital rate were to be harmed, the allowable harm would be lower.

Transient harm may be applied without jeopardizing survival or recovery if the population is not in decline. A one-time removal of ~35% of the total population will result in a 0.05% decline in population growth rate for a stable population. Removal of >75% of all individuals once every 10 years will reduce the growth rate below 1 if the population is growing at $\lambda = 1.2$ (i.e., a value greater than this removal will result in a decreasing population). Absolute numbers for removal should be chosen based on the population abundance. Allowable transient harm may be smaller if the population is growing at a slower rate. We caution that any removal affects population growth rate and will delay recovery and that current population abundance estimates are very uncertain.

SOURCES OF UNCERTAINTY

There is a need for more information about current population trends at the HUC level. There is also a need for life history data from a wider geographical range and from more recent years, with most of the data being collected several years ago from only the Tri-Creeks watershed. In particular data are needed to determine if the life history parameters for the river migrant population are different than the stream residents (i.e., survival rates and growth). In addition, the relative proportion of stream residents and river migrants in the different populations at the HUC level is unclear.

Finally, estimates of MAPV are based on a general relationship between benchmark Athabasca Rainbow Trout density and area (API) and may not effectively represent area required to complete all life stages and/or migration. Species-specific estimates of area per individual that are based on Athabasca Rainbow Trout movements and habitat use will reduce uncertainty in

this estimate. The estimate of required habitat (MAPV) assumes that habitat is of high quality throughout the range of Athabasca Rainbow Trout. There is not sufficient data to either confirm, or provide an alternative to this assumption; however, one of the main potential threats to the Athabasca Rainbow Trout population is habitat degradation (COSEWIC 2014).

REFERENCES CITED

- Alberta Environment and Parks (AEP). 2014. Athabasca Rainbow Trout Fish Sustainability Index. Alberta Fish and Wildlife Policy Branch, Edmonton, Alberta.
- Alberta Sustainable Resource Development and Alberta Conservation Association. 2009. Status of the Athabasca Rainbow Trout (*Oncorhynchus mykiss*) in Alberta. Alberta Sustainable Resource Development. Wildlife Status Report No. 66. Edmonton, AB. 32 p.
- Caswell, H. 2001. Matrix population models: construction, analysis, and interpretation. Sinauer Associates. 722 p.
- COSEWIC. 2014. COSEWIC assessment and status report on the Rainbow Trout *Oncorhynchus mykiss* in Canada. Committee on the Status of Endangered Wildlife in Canada, Ottawa.
- de Kroon, H., Plaisier, A., van Groenendael, J., and Caswell, H. 1986. Elasticity: the relative contribution of demographic parameters to population growth rate. *Ecology* 67: 1427. doi:10.2307/1938700
- Dietz, K.G. 1971. The rainbow trout populations (*Salmo gairdneri*, Richardson) and other fish of three streams in the foothills of Alberta. Thesis (M.Sc.), University of Alberta, Edmonton, AB.
- DFO. 2007a. [Documenting habitat use of species at risk and quantifying habitat quality](#). DFO Can. Sci. Advis. Sec. Sci. Advis. Rep. 2007/038.
- DFO. 2007b. [Revised protocol for conducting recovery potential assessments](#). DFO Can. Sci. Advis. Sec. Sci. Advis. Rep. 2007/039.
- Lefkovitch, L.P. 1965. The study of population growth in organisms grouped by stages. *Biometrics* 21: 1–18. doi:10.2307/2528348
- R Core Team. 2015. R: A language and environment for statistical computing. R Foundation for Statistical Computing, Vienna, Austria.
- Randall, R.G., Minns, C.K., and Kelso, J.R.M. 1995. Fish production in freshwaters: Are rivers more productive than lakes? *Can. J. Fish. Aquat. Sci.* 52: 631–643. doi:10.1139/f95-063
- Reed, D.H., O'Grady, J., Ballou, J.D., and Frankham, R. 2003. The frequency and severity of catastrophic die-offs in vertebrates. *Anim. Conserv.* 6: 109–114. doi:10.1017/S1367943003003147
- Scott, D.P. 1962. Effect of food quantity on fecundity of Rainbow Trout, *Salmo gairdneri*. *J. Fish. Res. Board Can.* 19: 715–731. doi:10.1139/f62-047
- Shaffer, M.L. 1981. Minimum population sizes for species conservation. *BioScience* 31: 131–134. doi:10.2307/1308256
- Sterling, G.L. 1990. Population dynamics of Rainbow Trout (*Oncorhynchus mykiss*) in the Tri-Creeks experimental Watershed of west-central Alberta; a postlogging evaluation (Research Report No. 10), Tri-Creeks Experimental Watershed. St. Paul, AB.

-
- Vélez-Espino, L.A., and Koops, M.A. 2007. [Assessing allowable harm and recovery efforts in Lake Ontario Atlantic salmon \(*Salmo salar*\)](#). Can. Sci. Advis. Sec. Sci. Advis. Rep. 2007/083.
- Vélez-Espino, L.A., and Koops, M.A. 2009a. Recovery potential assessment for Lake Sturgeon in Canadian designatable units. North Am. J. Fish. Manag. 29: 1065–1090. doi:10.1577/M08-034.1
- Vélez-Espino, L.A., and Koops, M.A. 2009b. Quantifying allowable harm in species at risk: application to the Laurentian black redbreast (*Moxostoma duquesnei*). Aquat. Conserv. Mar. Freshw. Ecosyst. 19: 676–688. doi:10.1002/aqc.1023
- Vélez-Espino, L.A., Randall, R.G., and Koops, M.A. 2009. [Quantifying habitat requirements of four freshwater species at risk in Canada: Northern Madtom, Spotted Gar, Lake Chubsucker, and Pugnose Shiner](#). Can. Sci. Advis. Sec. Sci. Advis. Rep. 2009/115.
- Vélez-Espino, L.A., McLaughlin, R.L., and Robillard, M. 2013. Ecological advantages of partial migration as a conditional strategy. Theor. Popul. Biol. 85: 1–11.
- Walters, C.J., and Post, J.R. 1993. Density-dependent growth and competitive asymmetries in size-structured fish populations: A theoretical model and recommendations for field experiments. Trans. Am. Fish. Soc. 122: 34–45. doi:10.1577/1548-8659(1993)122<0034:DDGACA>2.3.CO;2
- Young, J.A., and Koops, M.A. 2011. [Recovery potential modelling of Lake Chubsucker \(*Erimyzon sucetta*\) in Canada](#). Can. Sci. Advis. Sec. Sci. Advis. Rep. 2011/049.

APPENDIX 1

The best case scenario for the time to recovery was estimated by projecting the current estimate of adult abundance using the upper 95% confidence interval of the estimated population growth rates. At this rate, most of the HUC8 populations that are not considered extirpated, if considered in isolation, would reach the potential adult population abundance (based on the benchmark of 23 adults/0.1 ha) in 10–15 years. Only two of the HUCs would reach the most conservative MVP within 20 years. Simulations were not done for HUCs where Athabasca Rainbow Trout are considered extirpated.

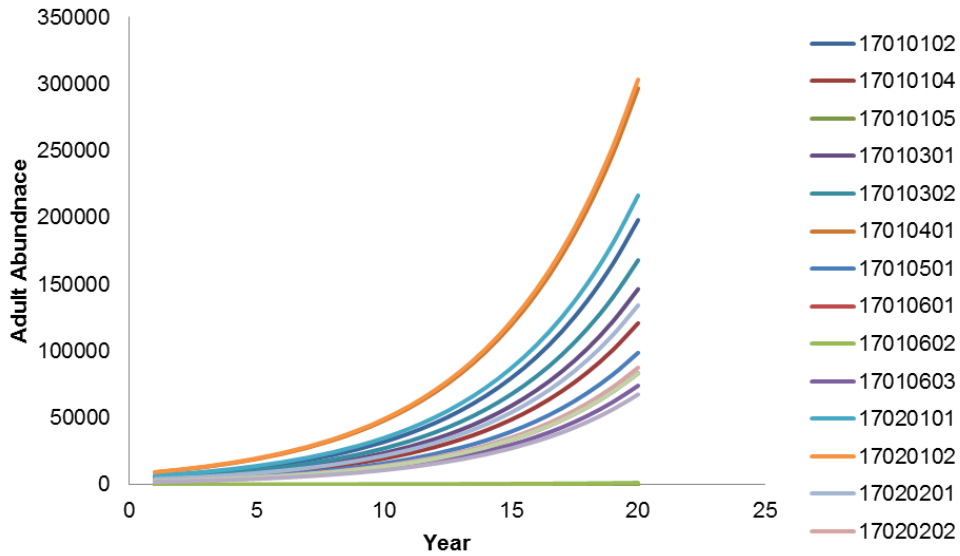

Figure A1-1. The projected adult abundance for each HUC8, if the Athabasca Rainbow Trout populations were growing at a rate of $\lambda = 1.2$.

APPENDIX 2

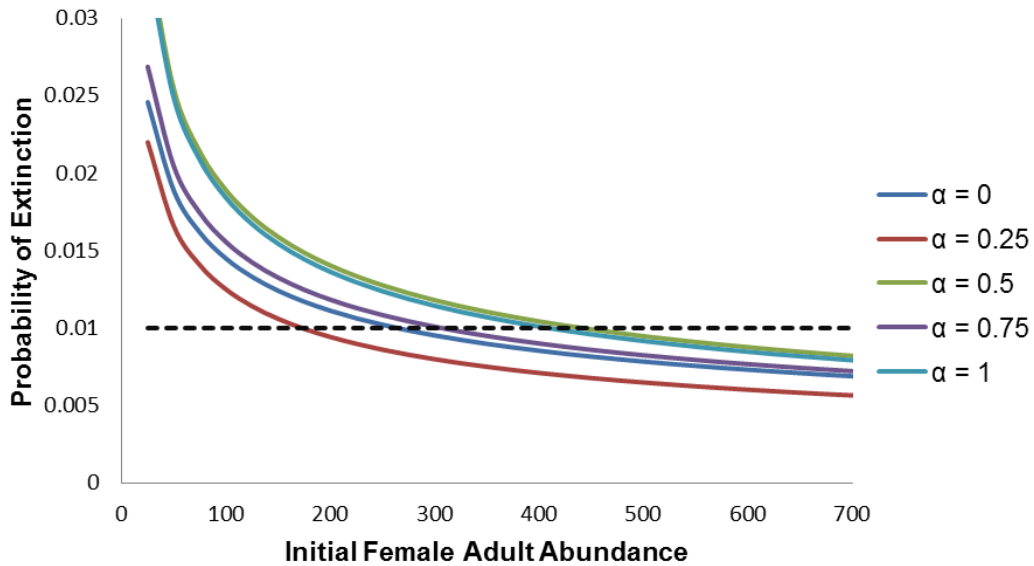

Figure A2-1. The probability of extinction for Athabasca Rainbow Trout for an extinction threshold of 2 adults and risk of catastrophe per generation of 10% for different proportions of the population that are considered stream resident (α).

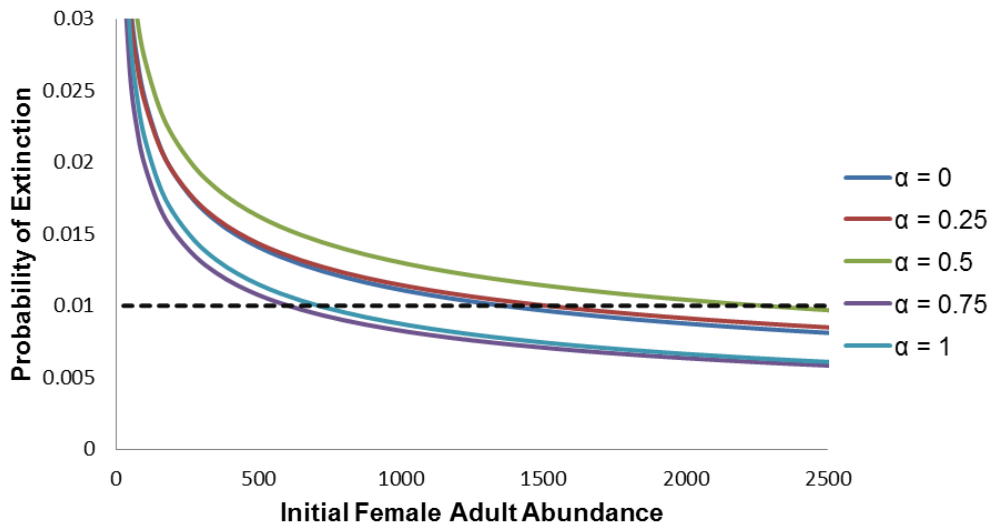

Figure A2-2. The probability of extinction for Athabasca Rainbow Trout for an extinction threshold of 2 adults and risk of catastrophe per generation of 15% for different proportions of the population that are considered stream resident (α).

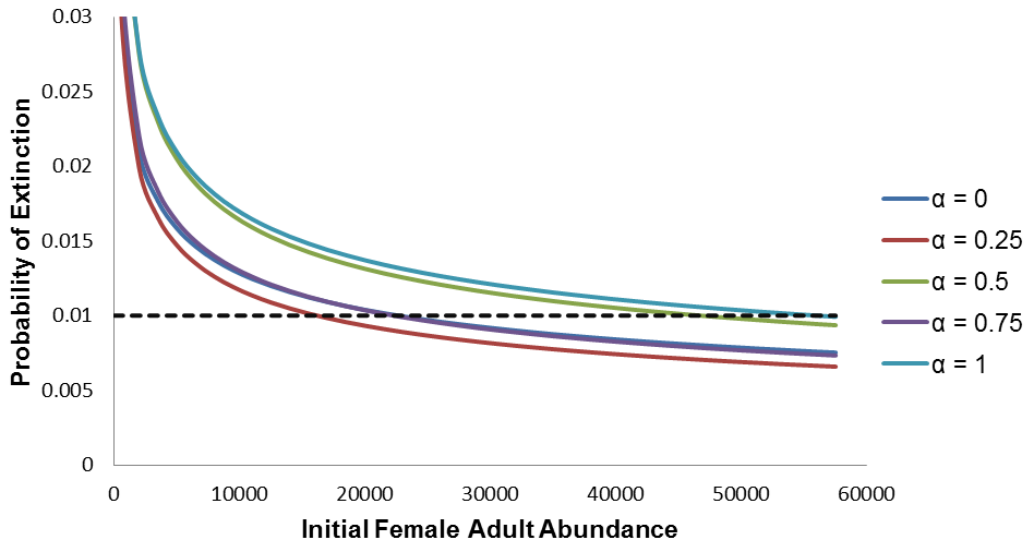

Figure A2-3. The probability of extinction for Athabasca Rainbow Trout for an extinction threshold of 50 adults and risk of catastrophe per generation of 10% for different proportions of the population that are considered stream resident (α).

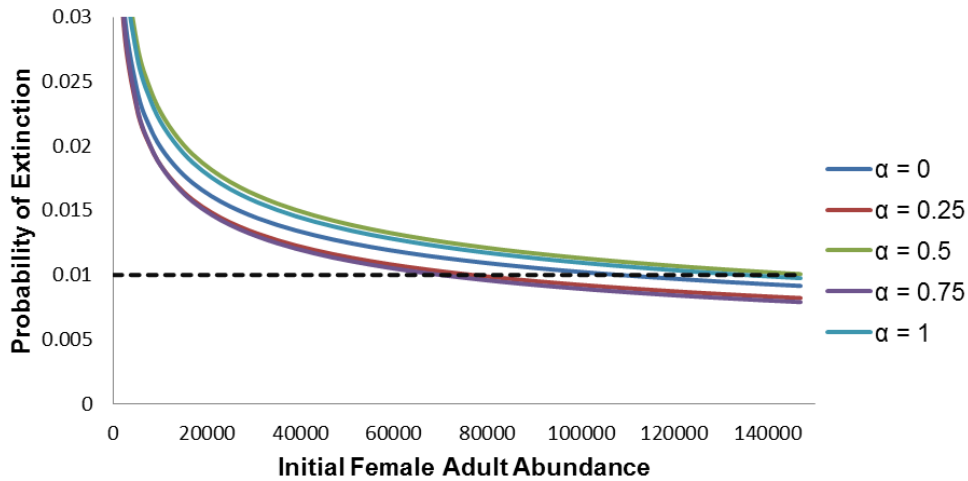

Figure A2-4. The probability of extinction for Athabasca Rainbow Trout for an extinction threshold of 50 adults and risk of catastrophe per generation of 15% for different proportions of the population that are considered stream resident (α).

APPENDIX 3

Table A3-1. Estimates of the minimum viable population (MVP) and the respective parameters (a, b) for the equation to estimate the probability of extinction (P_{ext}) for the extinction thresholds of 2 and 50 adults and the probability of catastrophe per generation of 10% and 15%. Results are broken down for populations with the proportion of the population that are stream residents (α) of 0, 0.25, 0.5, 0.75, and 1.

$\alpha = 0$

Extinction Threshold	2		50	
	10	15	10	15
Probability of Catastrophe				
<i>a</i>	0.08	0.12	0.21	0.29
<i>b</i>	-0.38	-0.34	-0.30	-0.29
0.1% Probability of Extinction	220,325	2,262,015	86,331,803	597,384,391
1% Probability of Extinction	528	2,722	45,277	216,542
3% Probability of Extinction	30	110	1,232	4,942
5% Probability of Extinction	8	25	231	852
7.5% Probability of Extinction	3	8	61	211
10% Probability of Extinction	1	3	24	78

$\alpha = 0.25$

Extinction Threshold	2		50	
	10	15	10	15
Probability of Catastrophe				
<i>a</i>	0.08	0.11	0.24	0.31
<i>b</i>	-0.41	-0.32	-0.33	-0.30
0.1% Probability of Extinction	98,070	3,627,710	35,063,912	297,858,976
1% Probability of Extinction	346	3,032	32,316	153,654
3% Probability of Extinction	23	103	1,151	4,150
5% Probability of Extinction	7	21	244	774
7.5% Probability of Extinction	2	6	71	204
10% Probability of Extinction	1	3	30	79

$\alpha = 0.5$

Extinction Threshold	2		50	
	10	15	10	15
Probability of Catastrophe				
<i>a</i>	0.14	0.12	0.32	0.37
<i>b</i>	-0.43	-0.32	-0.32	-0.30
0.1% Probability of Extinction	190,002	6,064,467	121,920,078	599,908,605
1% Probability of Extinction	882	4,551	93,480	300,360
3% Probability of Extinction	68	147	3,050	7,997
5% Probability of Extinction	21	30	621	1,482
7.5% Probability of Extinction	8	8	176	389
10% Probability of Extinction	4	3	72	150

Table A3-1 continued

$\alpha = 0.75$

Extinction Threshold Probability of Catastrophe	2		50	
	10	15	10	15
<i>a</i>	0.10	0.11	0.27	0.35
<i>b</i>	-0.39	-0.38	-0.33	-0.32
0.1% Probability of Extinction	210,185	524,739	50,226,845	194,424,469
1% Probability of Extinction	613	1,210	44,540	139,967
3% Probability of Extinction	38	67	1,558	4,432
5% Probability of Extinction	10	17	328	890
7.5% Probability of Extinction	4	6	95	249
10% Probability of Extinction	2	3	39	101

$\alpha = 1$

Extinction Threshold Probability of Catastrophe	2		50	
	10	15	10	15
<i>a</i>	0.14	0.13	0.28	0.36
<i>b</i>	-0.43	-0.39	-0.31	-0.30
0.1% Probability of Extinction	166,520	489,236	207,317,375	549,823,287
1% Probability of Extinction	818	1,422	112,060	270,425
3% Probability of Extinction	65	88	3,095	7,139
5% Probability of Extinction	20	24	583	1,317
7.5% Probability of Extinction	8	9	155	344
10% Probability of Extinction	4	4	61	133